

MJS16K 12" 160 watt Fan Assembly Instructions

1. Do not remove label from underside of shroud as this will void the products limited warranty.
2. We do not recommend the use of nylon tie kits or any other "through core" mounting methods for this fan assembly. The 160 watt motors used in this fan assembly is too heavy and produce too much starting torque to be supported by the radiator fins. We recommend purchasing a prefabricated mounting kit **MARADYNE® MFA107** or fashioning metal brackets that will attach to at least four of the six ¼ - 20 nylon reinforced nuts pressed in the back of the shroud and then bolted to the U-channels of the radiator/heat exchanger (See Fig 1.). 1" X ¼-20 bolts are recommended to attach the brackets to the shroud. Bolts must **NOT** be long enough to contact the radiator/heat exchanger. See Fig 2 for bolt pattern.
3. The fans contained in this assembly are assembled in puller configuration from the factory. While these fans can be reversed to be pusher fans, We do not recommend using this assembly as pusher fans on the front side of the radiator due to the large amount of ram air that is blocked by the shroud. Fans used as pushers should only be used as a last resort when there are no other options for mounting. See Fig 3.
4. We recommend the use of a thermostatic fan relay harness with at least a 25 Amp relay and fuse for each fan in the assembly. Recommended wire harness: choose one of these, **MARADYNE® MFA100** (Adjustable temperature switch), **MARADYNE® MFA102** (185° temperature switch for carbureted engines) or **MARADYNE® MFA103** (195° temperature switch for fuel injected engines). Recommended wire gauge is 14 AWG.

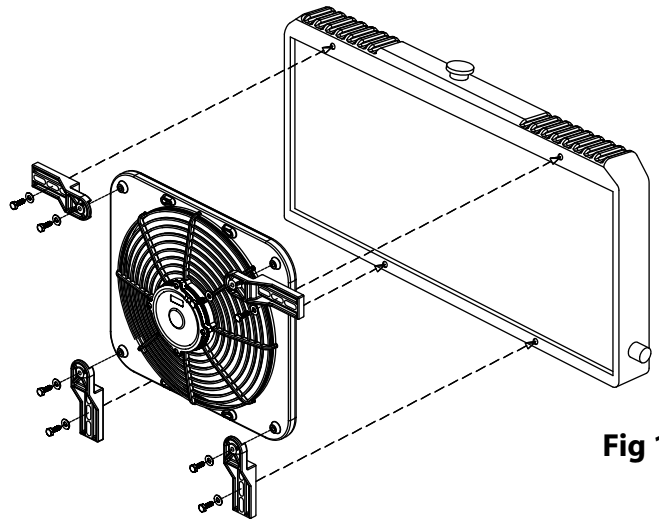

Fig 1

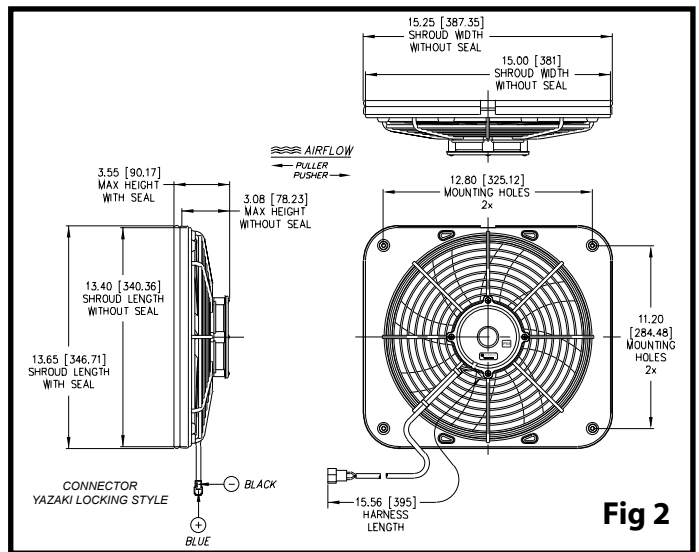

Fig 2

BLADE REVERSING INSTRUCTIONS

FANS SHIP IN PULLER CONFIGURATION

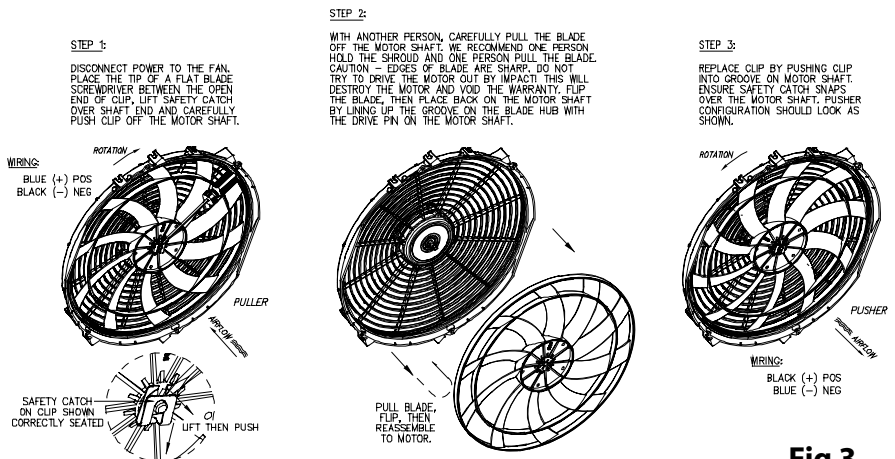

Fig 3

SPECIFICATIONS	
MOTOR	160 watt HEAVY DUTY
AIR FLOW @ 0" STATIC	1,300 CFM
SIZE	13.5" w x 15" h
DEPTH	3.62"
AMP DRAW	12.4